

M12 male 0° / M12 male 0° shielded X-cod. Gigabit

PUR 4x2xAWG26 shielded gn UL/CSA 5m

Ethernet CAT6A

Male straight – male straight

M12 – M12, 8-pole

X-coded

shielded

Transmission properties with channel transmission up to 50 m

Further cable lengths on request.

Plastic housings with good resistance against chemicals and oils.

The resistance to aggressive media should be individually tested for your application. Further details on request.

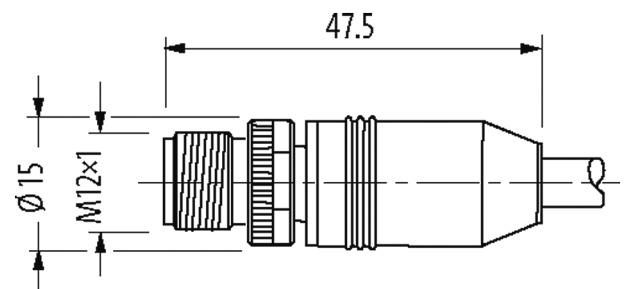
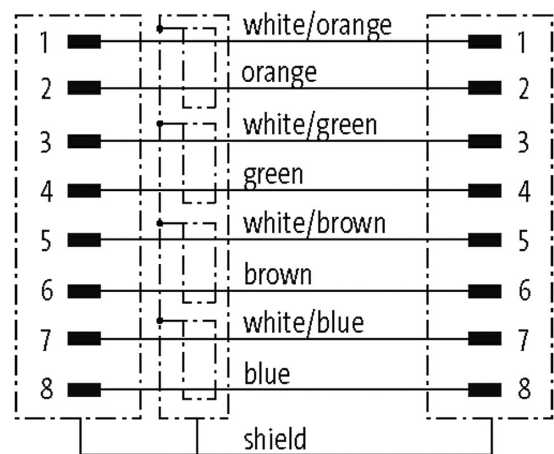
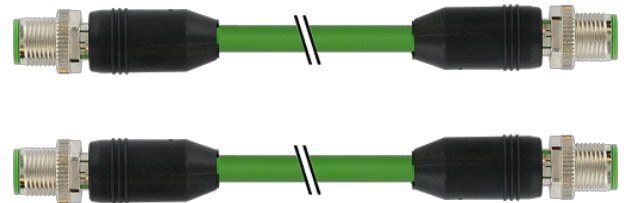
[Link to Product](#)**Illustration**

Product may differ from Image

Approvals



* only for products with UL/CSA approved cable

Form

Form 51001

General data

Standards	DIN EN 61076-2-109 (M12)
Mounting method	inserted, tightened
Material (contact)	Copper alloy
Material (contact surface)	Au
Pollution Degree	3
Temperature range	-25...+85 °C, depending on cable quality

Cables

No./diameter of wires	4 × 2 × 0.14 mm ²
Wire isolation	PE (whbl, bl, whor, or, whgn, gn, whbr, br)
Material (jacket)	PUR (UL/CSA)
Outer Ø	6.4 mm ±5%
Bend radius (moving)	10 × outer Ø
Temperature range (fixed)	-30...+80 °C
Temperature range (mobile)	-10...+50 °C
Cable identification	790
Approval (cable)	UL (AWM-Style 20236/1598), CSA; CE
Cable weight [g/m]	52,80
Material (wire)	Cu wire, bare
Resistor (core)	max. 143 Ω/km (20 °C)
Single wire Ø (core)	0.16 mm
Diameter (core)	4 × 2 × 0.14 mm ²
Material (wire isolation)	PE
Wire-Ø incl. isolation	1.05 mm ±5%
Color/numbering of wires	wh/or+or, wh/bl+bl, wh/br+br, wh/gn+gn
Shield	yes
	min. 65%
Material (jacket)	PUR
Outer-Ø (jacket)	6.4 mm ±5%
Color (jacket)	green
thermal resistance	flame retardant
Nominal voltage	125 V AC
Test voltage	1500 V (wire/wire); 1000 V (wire/shield)
Temperature range (fixed)	-40...+80 °C
Temperature range (mobile)	-10...+50 °C
Bend radius (fixed)	8 × outer Ø
Bend radius (moving)	10 × outer Ø
Jacket Color	green

Technical Data

Operating voltage	max. 50 V AC/60 V DC
Operating voltage (only UL listed)	30 V AC/DC
Rated surge voltage	1.5 kV

Operating current per contact	max. 0.5 A
No. of poles	8
Transfer parameters	CAT6, Class EA (ISO/IEC 11801:2002), (EN 50173-1)
Transfer rate	10 Gbit/s
Material group	IEC 60664-1, category I
Coding	X-coded
LED display	no
Locking of ports	Screw thread (M12×1 mm) recommended torque 0.6 Nm, self-securing
Compression gland	M12 (SW13)
Protection	IP65 and IP67 when plugged and screwed down (EN 60529)
Material	PUR
Locking material	Zinc die casting, matte nickel plated
suitable for corrugated tube (internal Ø)	without

Commercial data

country of origin	DE
customs tariff number	85444290
EAN	4048879536684
eClass	27061801
Packaging unit	1